



Alberti
SWISS TOOL
Selection Guide



TORNOS SWISS TOOLING

**Alberti TORNOS SWISS TOOLS for
DECO 10 • DECO 13 • DECO 20**

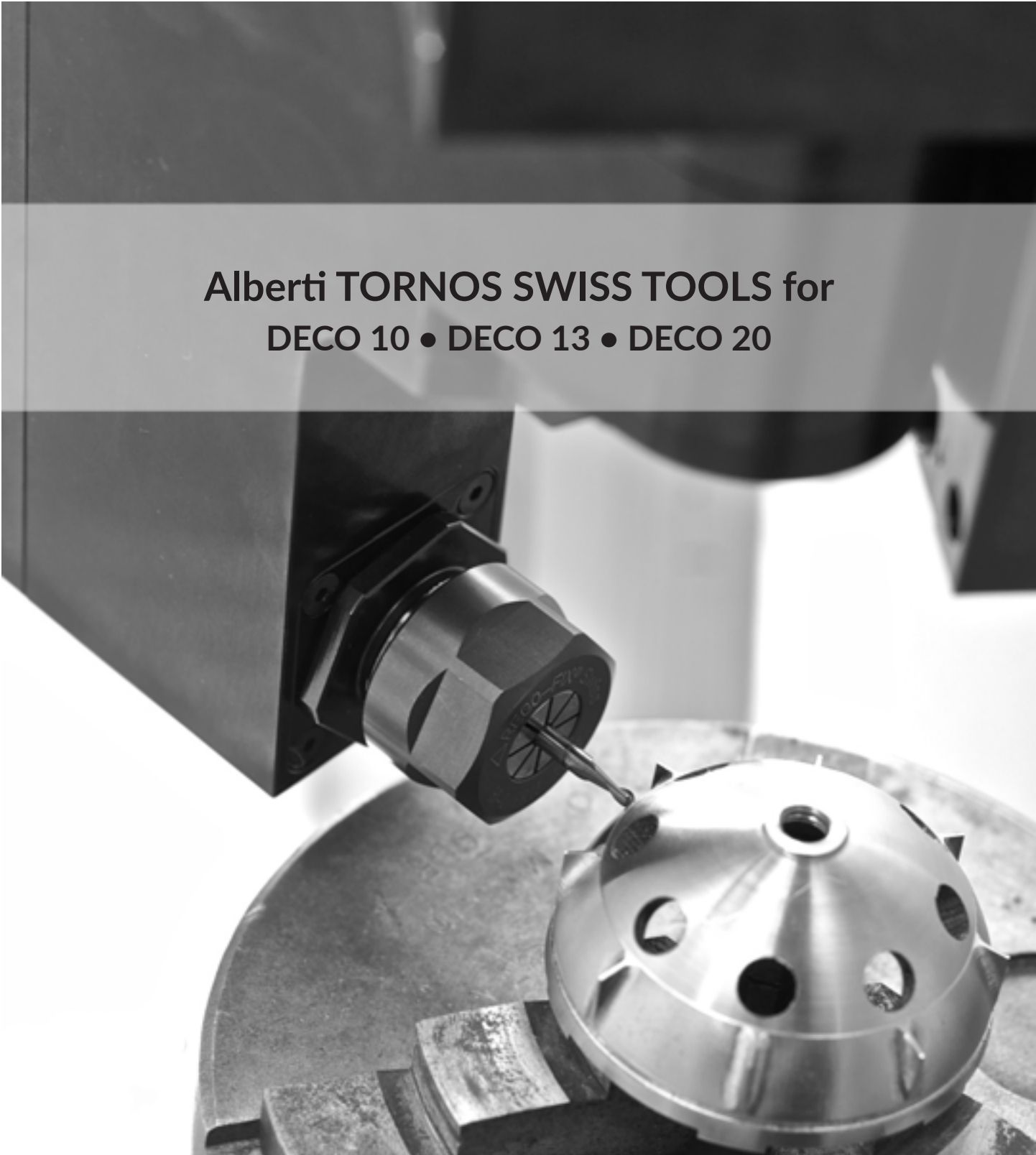

TORNOS

p. 3-5

Complete Series for TORNOS DECO 10

DECO 10

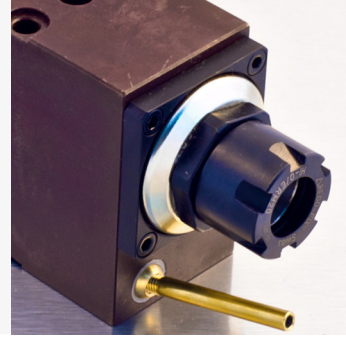

TORNOS

p. 6-8

Complete Series for TORNOS DECO 13

DECO 13



TORNOS

p. 9-13

Complete Series for TORNOS DECO 20

DECO 20

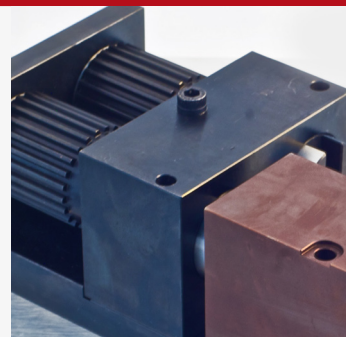

DECO 10 9 axes with end attachment and counter-spindle

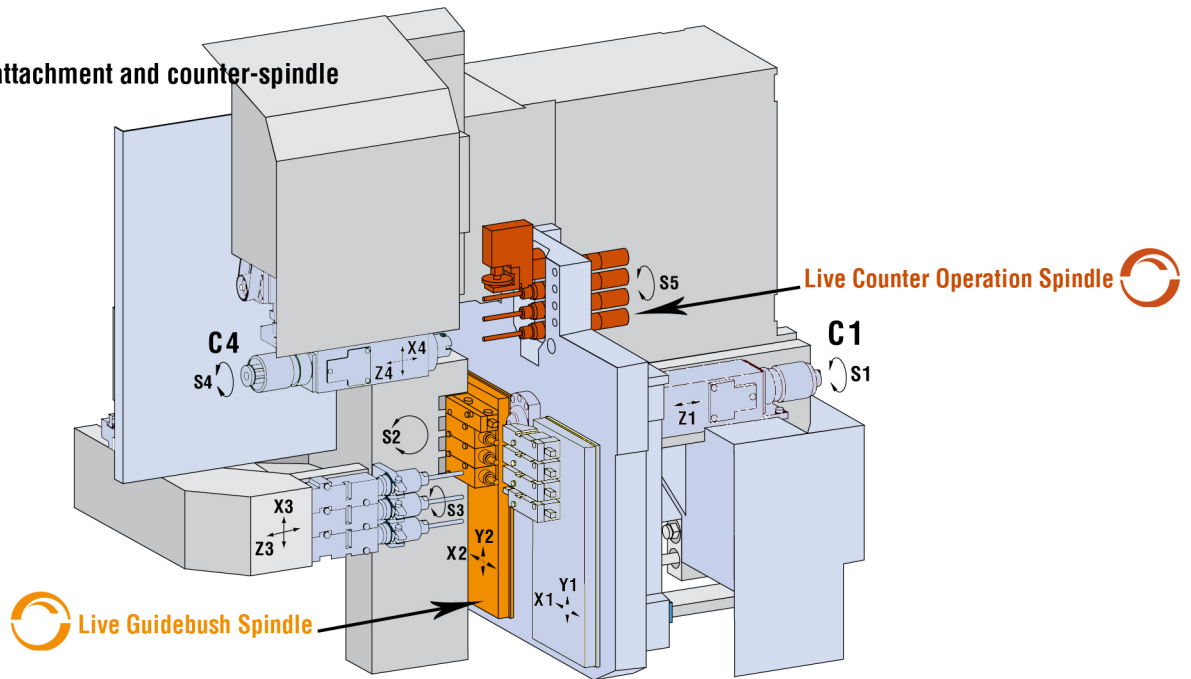

ATO.DE.10.0115 Axial Short

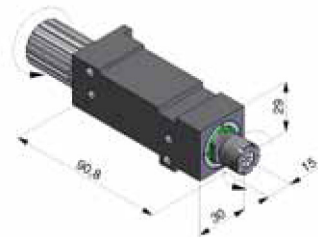

Collet	ER 11
Ratio	1:1
RPM	12,000 Max.
Transmission	Pulley
Lubrication	Lifelong

ATO.DE.10.0130 Axial Long

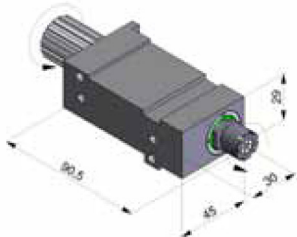

Collet	ER 11
Ratio	1:1
RPM	12,000 Max.
Transmission	Pulley
Lubrication	Lifelong

ATO.DE.10.1103 Axial 3 Output

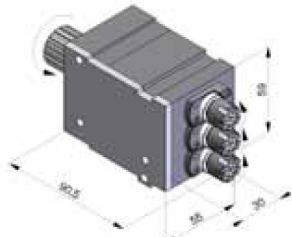

Collet	ER 11
Ratio	1:1
RPM	12,000 Max.
Transmission	Pulley
Lubrication	Lifelong

TORNOS DECO 10



ATO.DE.10.0100 Axial Counter-Operation



Collet	ER 11
Ratio	1:1
RPM	12,000 Max.
Transmission	Pulley
Lubrication	Lifelong

ATO.DE.10.0210 Radial Counter-Operation

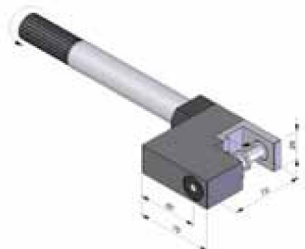

Collet	ER 11
Ratio	1:1
RPM	9,000 Max.
Transmission	Pulley
Lubrication	Lifelong

ATO.DE.10.0310 Adjustable Counter-Operation



Collet	ER 11
Ratio	1:1
RPM	9,000 Max.
Transmission	Pulley
Lubrication	Lifelong

ATO.DE.10.0300 Axial Adjustable 0-90°



Collet	ER 11
Ratio	1:1
RPM	12,000 Max.
Transmission	Pulley
Lubrication	Lifelong

ATO.DE.10.0320 Radial Adjustable 180°

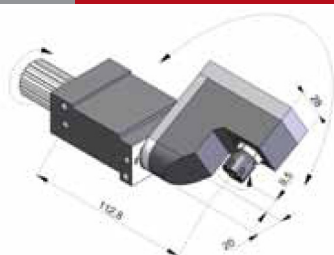

Collet	ER 11
Ratio	1:1
RPM	12,000 Max.
Transmission	Pulley
Lubrication	Lifelong

ATO.DE.10.0200

Radial

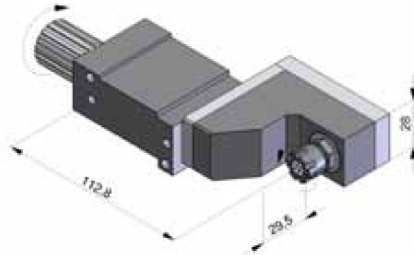

Collet	ER 11
Ratio	1:1
RPM	12,000 Max.
Transmission	Pulley
Lubrication	Lifelong

ATO.DE.10.2103

Radial 3 Output

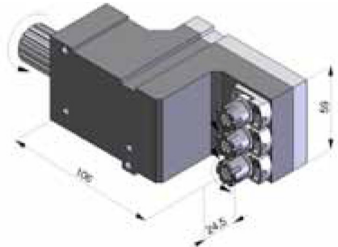

Collet	ER 11
Ratio	1:1
RPM	12,000 Max.
Transmission	Pulley
Lubrication	Lifelong

ATO.DE.10.1000

Polygon Holder

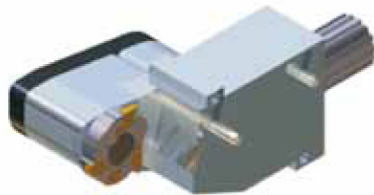

Attachment	Polygon Cutter
Ratio	1:1
RPM	8,000 Max.
Transmission	Pulley
Lubrication	Lifelong

ATO.DE.10.0800

Thread Whirling

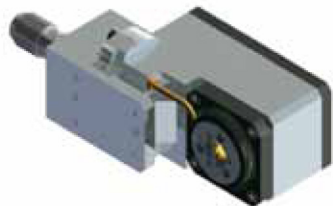

Attachment	Thread Whirling Head
Ratio	1:1
RPM	8,000 Max.
Transmission	Pulley
Lubrication	Lifelong

TORNOS DECO 13

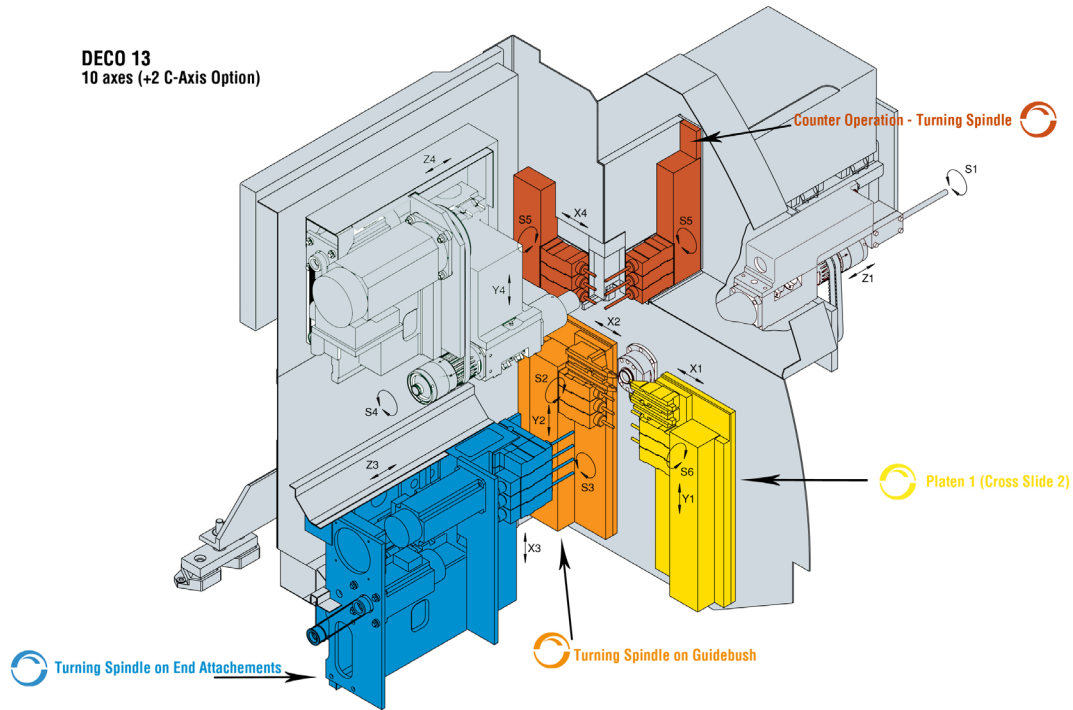

ATO.DE.13.0100 Axial Short



Collet	ER 16
Ratio	1:1
RPM	8,000 Max.
Transmission	Pulley
Lubrication	Lifelong

ATO.DE.13.0120 Axial Long

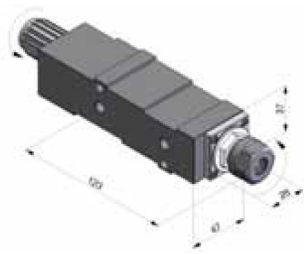

Collet	ER 16
Ratio	1:1
RPM	8,000 Max.
Transmission	Pulley
Lubrication	Lifelong

ATO.DE.13.1103 Axial 3 Output

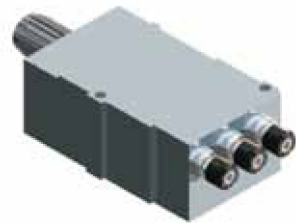

Collet	ER 11
Ratio	1:1
RPM	8,000 Max.
Transmission	Pulley
Lubrication	Lifelong

ATO.DE.13.0300

Axial Adjustable 0-90°

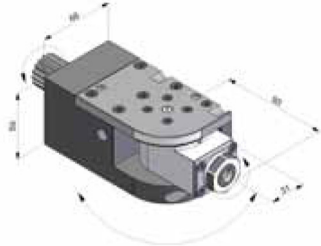

Collet	ER 11
Ratio	1:1
RPM	8,000 Max.
Transmission	Pulley
Lubrication	Lifelong

ATO.DE.13.0200

Radial

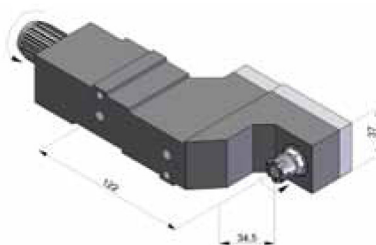

Collet	ER 11
Ratio	1:1
RPM	8,000 Max.
Transmission	Pulley
Lubrication	Lifelong

ATO.DE.13.2103

Radial 3 Output

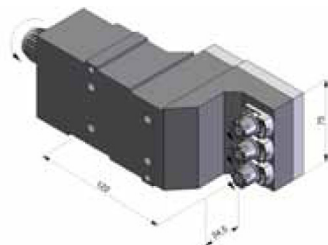

Collet	ER 11
Ratio	1:1
RPM	8,000 Max.
Transmission	Pulley
Lubrication	Lifelong

ATO.DE.13.0320

Radial Adjustable 180°

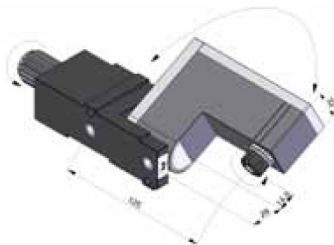

Collet	ER 11
Ratio	1:1
RPM	8,000 Max.
Transmission	Pulley
Lubrication	Lifelong

ATO.DE.13.0800

Axial Short

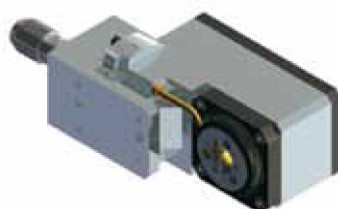

Attachment	Thread Whirling Head
Ratio	1:1
RPM	8,000 Max.
Transmission	Pulley
Lubrication	Lifelong

TORNOS DECO 10



ATO.DE.13.1000

Polygon Holder



Attachment	Polygon Cutter
Ratio	1:1
RPM	8,000 Max.
Transmission	Pulley
Lubrication	Lifelong

ATO.DE.13.0900

Hobbing Holder



Attachement	Spindle
Ratio	1:1
RPM	8,000 Max.
Transmission	Pulley
Lubrication	Lifelong

DECO 13
10 axes (+2 C-Axis Option)

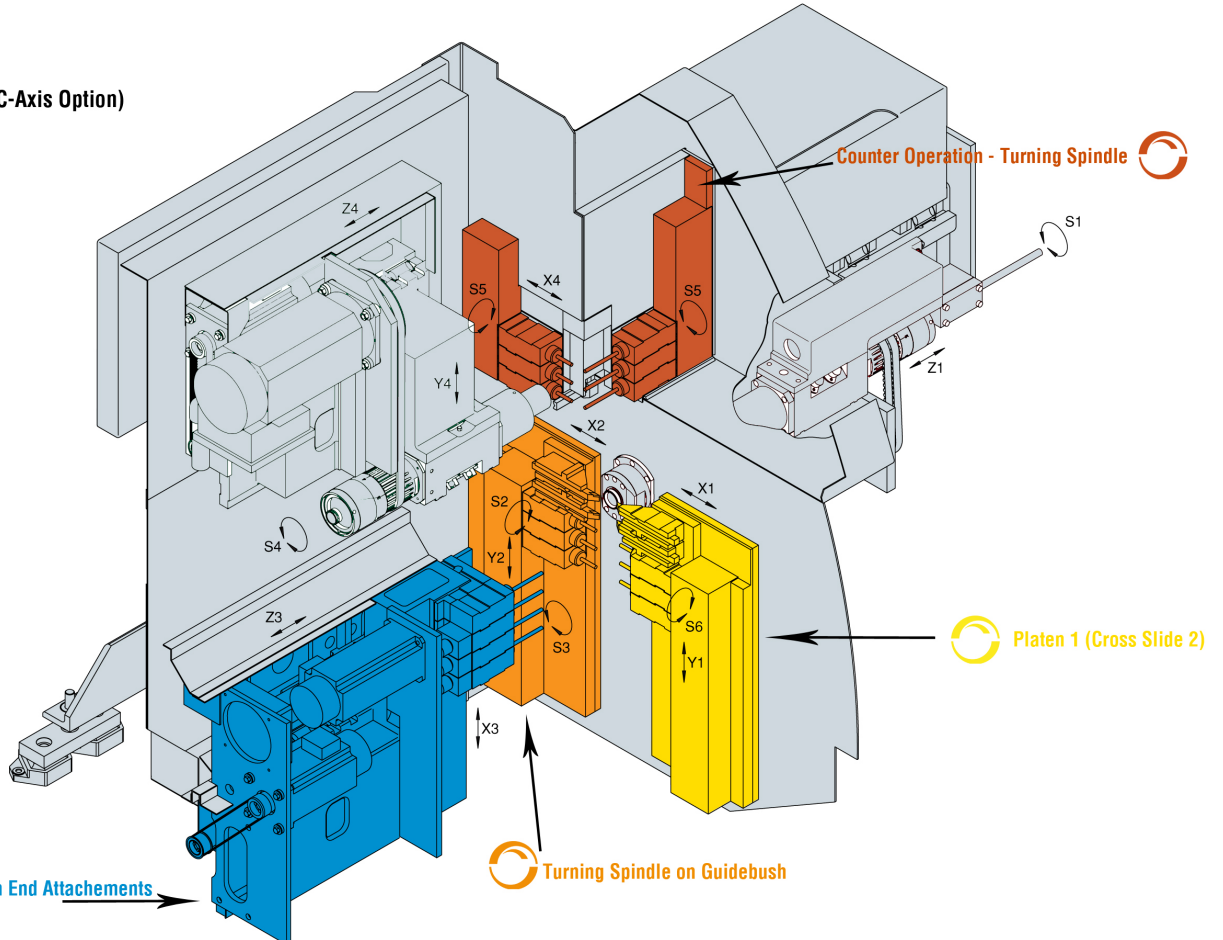

DECO 20
10 axes with end attachment
and counter spindle

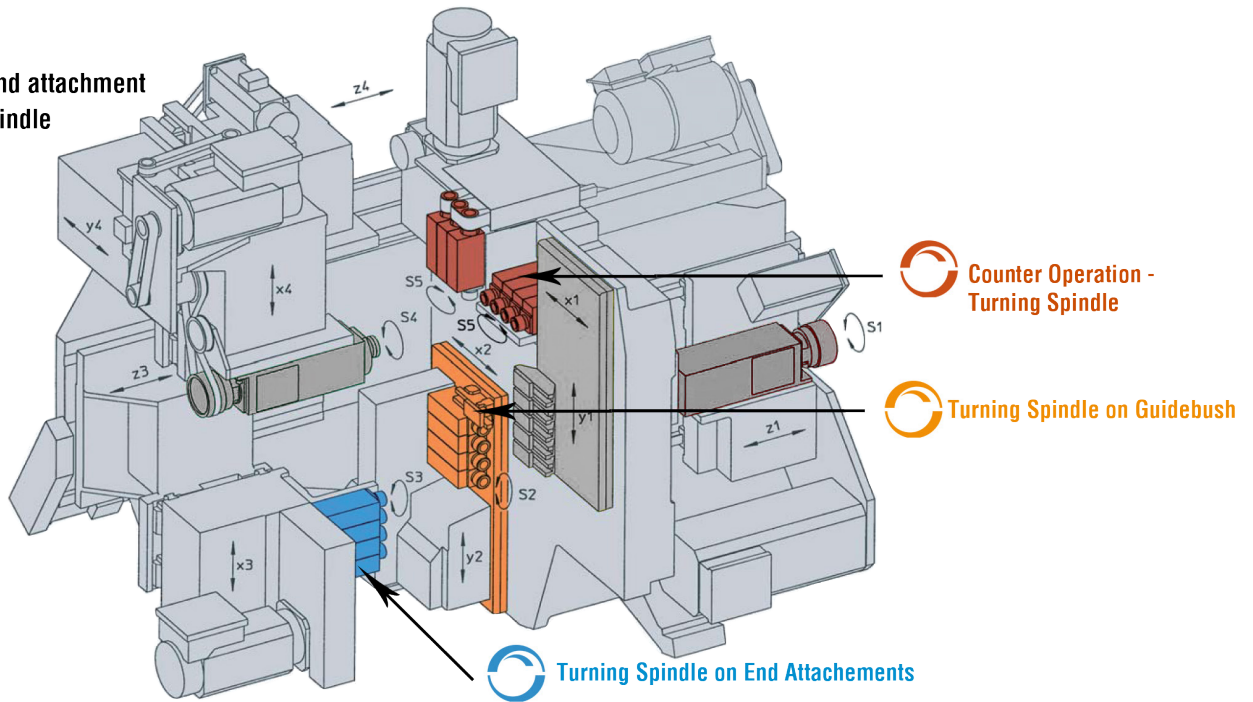

ATO.DE.20.0100 Axial Short



Collet	ER 20
Ratio	1:1
RPM	8,000 Max.
Transmission	Pulley
Lubrication	Lifelong

ATO.DE.20.0120 Axial Long



Collet	ER 20
Ratio	1:1
RPM	8,000 Max.
Transmission	Pulley
Lubrication	Lifelong

ATO.DE.20.1103 Axial 3 Output



Collet	ER 11
Ratio	1:1
RPM	8,000 Max.
Transmission	Pulley
Lubrication	Lifelong

TORNOS DECO 20



ATO.DE.20.0300 Axial Adjustable 0-90°

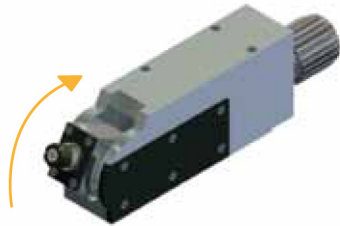

Collet	ER 11
Ratio	1:1
RPM	8,000 Max.
Transmission	Pulley
Lubrication	Lifelong

ATO.DE.20.0200 Radial



Collet	ER 20
Ratio	1:1
RPM	8,000 Max.
Transmission	Pulley
Lubrication	Lifelong

ATO.DE.20.2103 Radial 3 Output



Collet	ER 11
Ratio	1:1
RPM	8,000 Max.
Transmission	Pulley
Lubrication	Lifelong

ATO.DE.20.0320 Radial Adjustable 180°

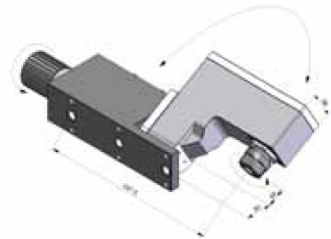

Collet	ER 16
Ratio	1:1
RPM	8,000 Max.
Transmission	Pulley
Lubrication	Lifelong

ATO.DE.20.0900 Hobbing Holder

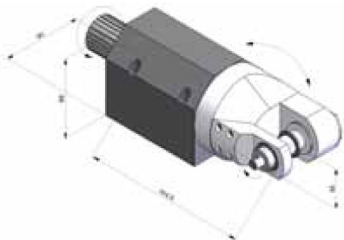

Attachment	Spindle \varnothing 13-16
Ratio	4:1
RPM	2,000 Max.
Transmission	Pulley
Lubrication	Lifelong

ATO.DE.20.0800 Thread Whirling

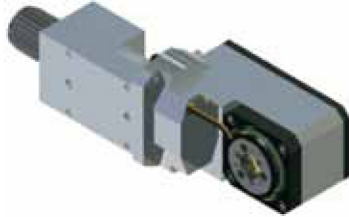

Attachment	Thread Whirling Head
Ratio	1:1
RPM	8,000 Max.
Transmission	Pulley
Lubrication	Lifelong

ATO.DE.20.1000 Polygon Holder

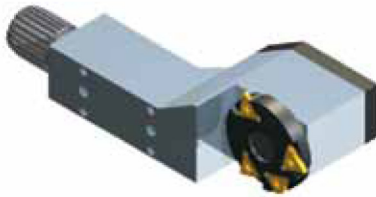

Attachment	Polygon Cutter
Ratio	1:1
RPM	8,000 Max.
Transmission	Pulley
Lubrication	Lifelong

ATO.DE.SYSTEM AM System

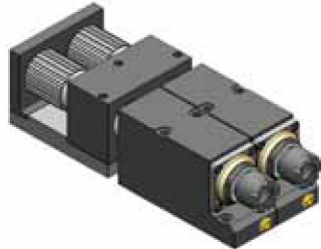

Collet	ER 20
Ratio	1:1
RPM	8,000 Max.
Transmission	Pulley
Lubrication	Lifelong

ATO.DE.20.1200 AM Base

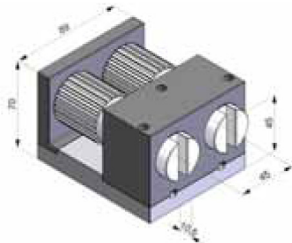

Collet	--
Ratio	1:1
RPM	8,000 Max.
Transmission	Pulley
Lubrication	Lifelong

ATO.DE.20.1210 AM Axial Short



Collet	ER 20
Ratio	1:1
RPM	8,000 Max.
Transmission	Pulley
Lubrication	Lifelong

TORNOS DECO 20



ATO.DE.20.1230

AM Axial Long



Collet	ER 20
Ratio	1:1
RPM	8,000 Max.
Transmission	Pulley
Lubrication	Lifelong

ATO.DE.20.1240

AM Radial

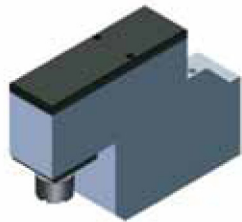

Collet	ER 20
Ratio	1:1
RPM	8,000 Max.
Transmission	Pulley
Lubrication	Lifelong

DECO 20
10 axes with end attachment
and counter spindle

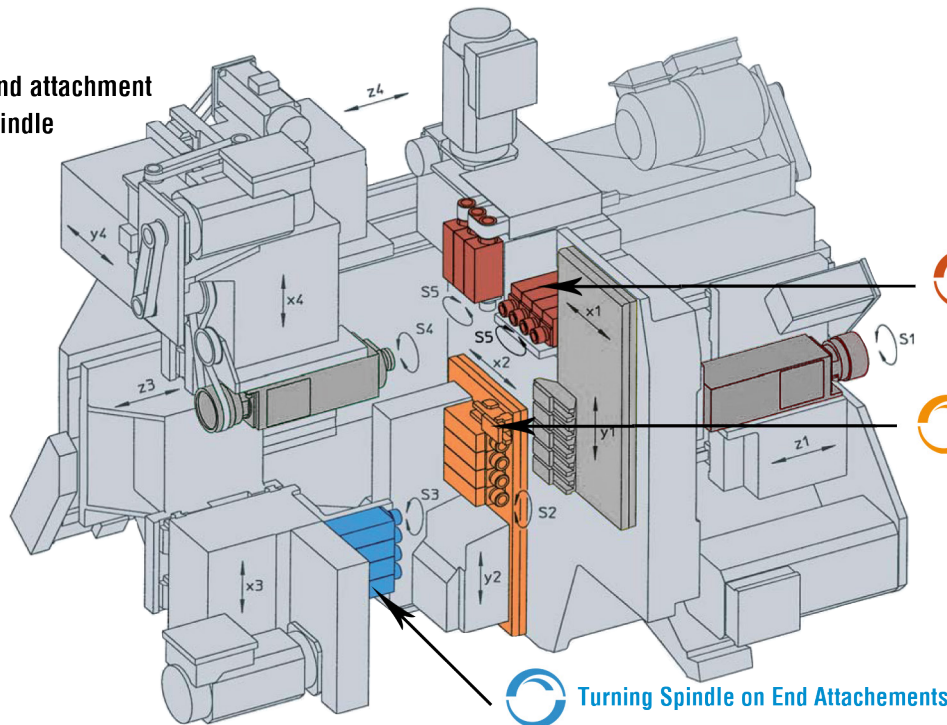

- Counter Operation - Turning Spindle
- Turning Spindle on Guidebush

Turning Spindle on End Attachments

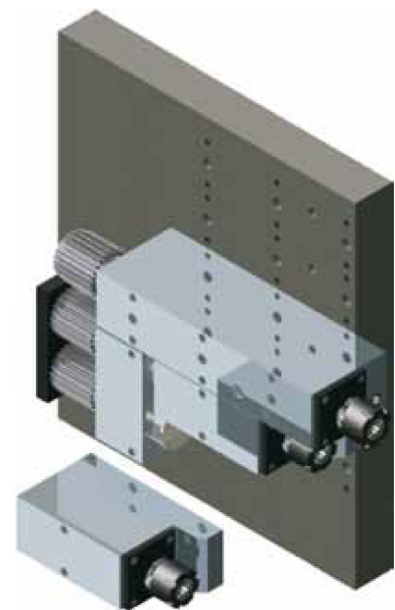
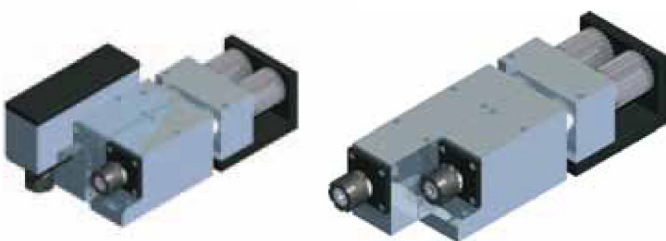
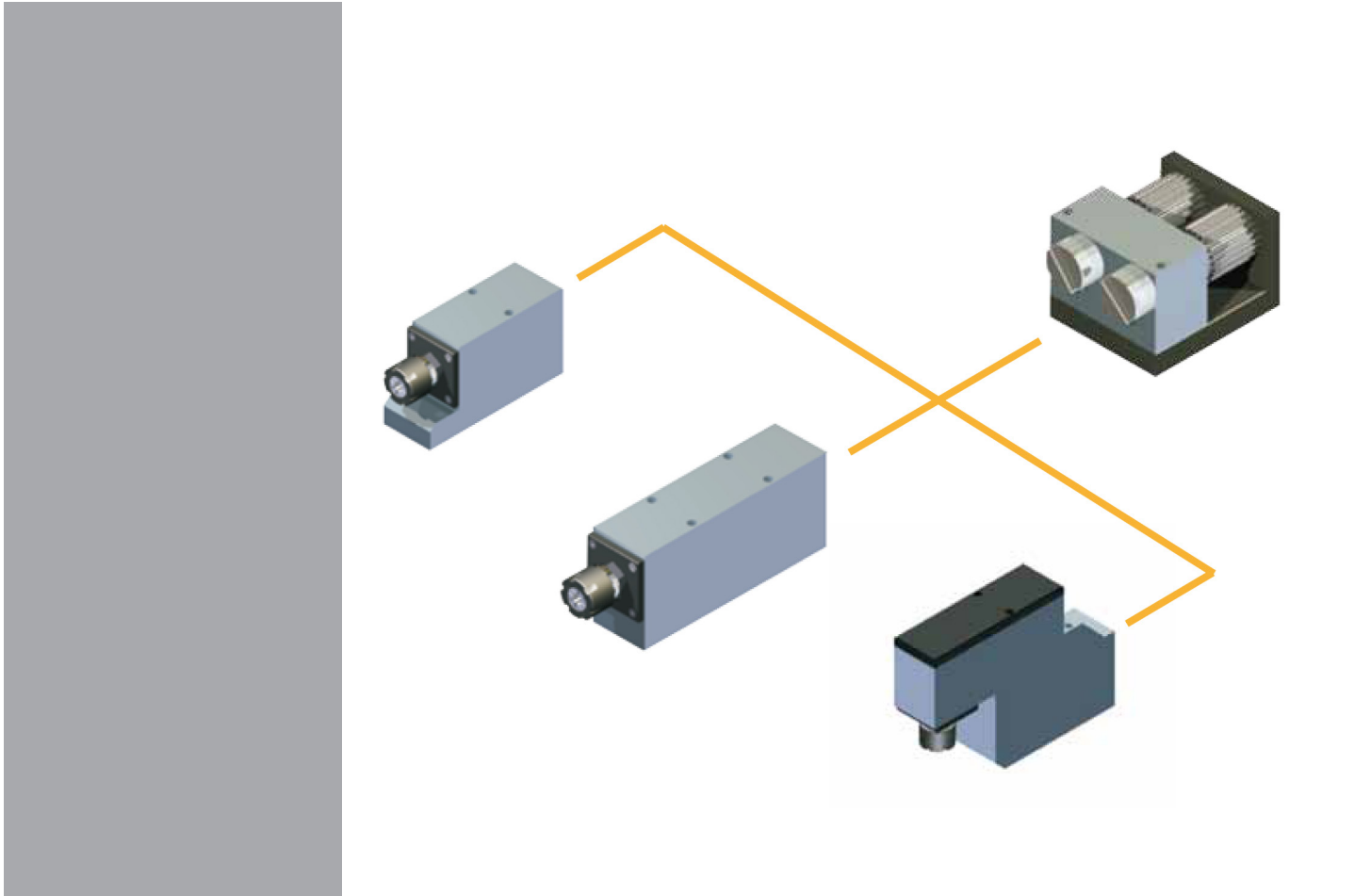

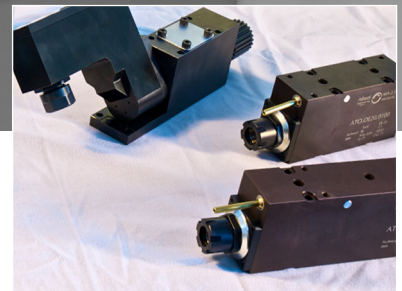
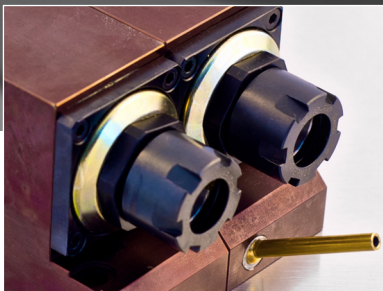



Tel: 1.800.249.5662
Fax: 860.623.4132

info@komaprecision.com
www.komaprecision.com

20 Thompson Road
East Windsor, CT 06088