

SLIMLINE
ANGLE HEADS

KOMA PRECISION

For over thirty-five years Koma Precision has been the foremost source for the finest the world has to offer in machine tool Productivity Innovation.

With over 30,000 rotary table installations, Koma is the largest distributor of Tsudakoma NC rotary tables and indexers in the world. With over 12,000 angle heads and live tools installed, Koma is the world's largest supplier for Alberti - the originator and the foremost innovator of productivity tooling.





T90sl-0.3 SLIMLINE NSK[®] OUTPUT ANGLE HEAD

DIMENSIONAL DRAWING

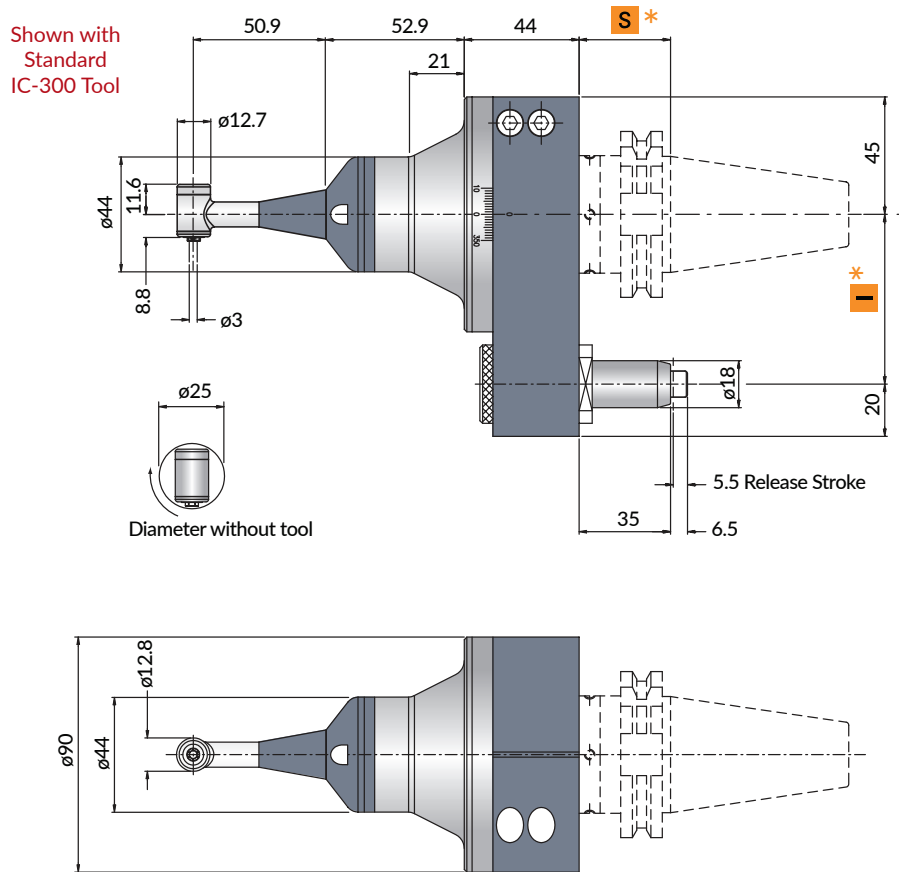

Optional Drive Shanks*

Non interchangeable input drive shank

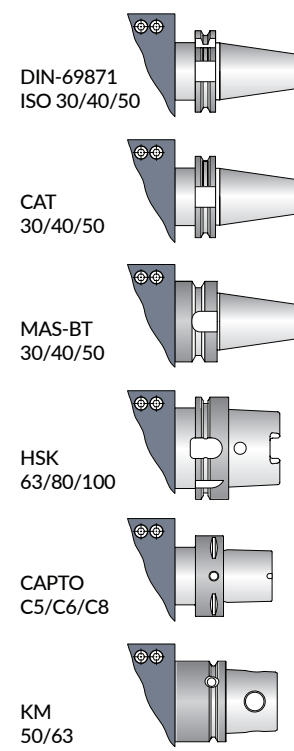

DIMENSIONAL DRAWING & OPTIONAL DRIVE SHANKS

TECHNICAL DATA

SHANK		DIN-69871 / CAT			MAS / BT			HSK		CAPTO		KM
	Size	30	40	50	30	40	50	63/80	100	C5/C6	C8	50/63
I	Arm Length (mm)	65,80	65,80 (110*)	80 (110*)	65,80	65,80 (110*)	80 (110*)	65,80 (110*)	80 (110*)	65,80 (110*)	80 (110*)	65,80 (110*)
S	Flange Spacing (mm)	35	35	35	30	35	41	42	45	38	40	40

T90sl-0.3 - with IC-300	
Ratio	1:75
Maximum Input RPM	15,000
Maximum Output RPM	11,250
Weight	7.7 lbs

Included with Tool:
Storage Case • Wrenches • Instruction Manual

DIMENSIONAL DRAWING

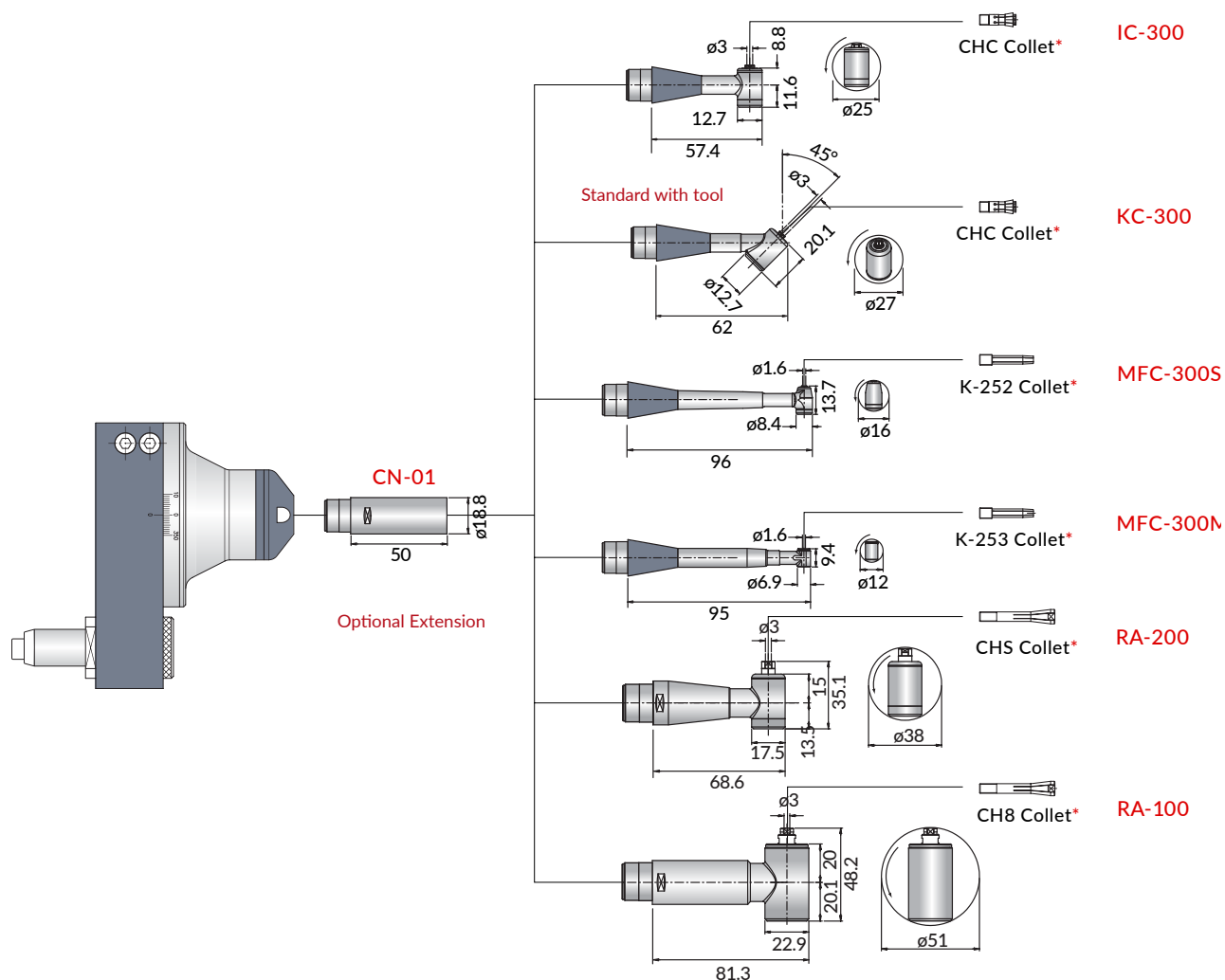

TECHNICAL DATA

	IC-300	KC-300	MFC-300S	MFC-300M	RA-200	RA-100	CN-01
Ratio	1:75	1:75	1:1	1:1	1:66	1:375	1:1
Max. NSK Output RPM	11,250	11,250	15,000	15,000	10,000	5,620	15,000
Torque	.74 ft lbs	.74 ft lbs	.74 ft lbs	.74 ft lbs	2.95 ft lbs	2.95 ft lbs	-
NSK Collet	CHC	CHC	K-252	K-253	CHS	CH8	-

Included with Tool: Storage Case • (1) NSK Tool • Wrenches • Instruction Manual

CHC (for IC-300, KC-300)



Model	Inside Diameter (mm)
GP-59021-00	1.6
GP-59024-00	2.35
GP-59015-00	3.0
GP-59010-00	3.175

CHS (for RA-200)

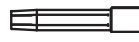

Model	Inside Diameter (mm)
GP-59027-00	0.8
GP-59028-00	0.9
GP-59029-00	1.0
GP-59030-00	1.1
GP-59031-00	1.2
GP-59032-00	1.3
GP-59033-00	1.4
GP-59034-00	1.5
GP-59012-00	1.6
GP-59035-00	1.7
GP-59036-00	1.8
GP-59037-00	1.9
GP-59016-00	2.0
GP-59038-00	2.1
GP-59039-00	2.2
GP-59040-00	2.3
GP-59041-00	2.35
GP-59042-00	2.4
GP-59013-00	2.5
GP-59043-00	2.6
GP-59044-00	2.7
GP-59045-00	2.8
GP-59046-00	2.9
GP-59009-00	3.0
GP-59011-00	3.175

CH8 (for RA-100)



Model	Inside Diameter (mm)
GP-59047-00	0.8
GP-59048-00	0.9
GP-59049-00	1.0
GP-59050-00	1.1
GP-59051-00	1.2
GP-59052-00	1.3
GP-59053-00	1.4
GP-59054-00	1.5
GP-59055-00	1.6
GP-59056-00	1.7
GP-59057-00	1.8
GP-59058-00	1.9
GP-59059-00	2.0
GP-59060-00	2.1
GP-59061-00	2.2
GP-59062-00	2.3
GP-59063-00	2.35
GP-59064-00	2.4
GP-59065-00	2.5
GP-59066-00	2.6
GP-59067-00	2.7
GP-59068-00	2.8
GP-59069-00	2.9
GP-59070-00	3.0
GP-59008-00	3.175

K-252 (for MFC-300S)

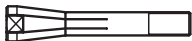

Model	Inside Diameter (mm)
GP-59025-00	1.6

K-253 (for MFC-300M)

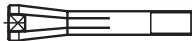

Model	Inside Diameter (mm)
GP-59026-00	1.6

OPTIONAL STOP BLOCK

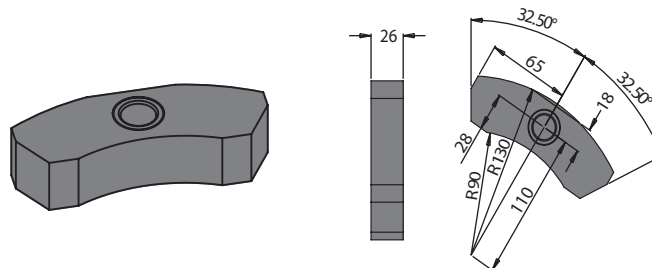



Tel: 1.800.249.5662
Fax: 860.623.4132

info@komaprecision.com
www.komaprecision.com

20 Thompson Road
East Windsor, CT 06088